

series A, E, G, H, L, P, SR



Operating instructions

Contents

1 - General safety instructions	4
1.1 - Disposal and recycling	4
1.2 - Safety	4
1.2.1 - Residual risks	5
2 - Operating conditions	6
3 - How supplied	6
3.1 - Receipt	6
3.2 - Name plate	6
3.3 - Painting	6
3.4 - Protections and packing	6
4 - Storing	6
5 - Installation	7
5.1 - General	7
5.2 - Fitting of components to shaft ends	8
5.3 - Shaft mounting	8
5.4 - Hollow low speed shaft	8
5.5 - Backstop device	9
5.6 - Shrink disc	9
6 - Lubrication	12
6.1 - General	12
6.2 - Lubrication table	10
6.3 - Extruder support lubrication	12
7 - Cooling system	12
7.1 - Cooling by fan	12
7.2 - Water cooling by coil	13
7.3 - Independent cooling unit	13
8 - Commissioning	13
9 - Maintenance	13
9.1 - General	13
9.2 - Coil	14
9.3 - Seal rings	14
9.4 - IEC motor mounting and dismounting	14
9.5 - Servomotor mounting and dismounting	17
9.6 - Bearings	17
9.7 - Metal filler plug with filter and valve	17
10 - Sound levels	18
Painting table	18
Table of tightening torques for axial fastening bolts and shrink disc	18
Table of tightening torques for fastening bots (foot, flange, hub clamps and flexible half-coupling bolts)	19
Table of tightening torques for plugs	19
Gear reducer troubles: causes and corrective actions	20

1 - General safety information

This document provides information about handling, installation and maintenance of helical and bevel helical gear reducers and gearmotors (G series).

All the people involved in these activities will carefully read and follow all present instructions.

Information and data contained in this document correspond to the technical level reached at the moment the catalog is printed. Rossi reserves the right to introduce, without notice, the necessary changes to improve efficiency and safety of its products.

1.1 - Disposal and recycling

Keep in mind the instructions in force concerning exhaust disposal and recycling:



- elements of gear reducer housing, gear pairs, shafts and bearings must be transformed into steel scraps along with all other cast iron components, excluding specific cases;
- for all other non-metallic components (seal rings, caps, etc.) follow the instructions in force;
- all exhaust oils must be recycled and treated as per regulations in force.

1.2 - Safety

The paragraphs marked with symbols shown below contain dispositions to be strictly respected in order to assure personal **safety** and to avoid any heavy **damages** to the machine or to the system.



(Electric or mechanical) danger, such as:

- live parts;
- temperature higher than 50 °C;
- components rotating during operation;
- suspended loads (lifting and transport);
- eventual high sound level (> 85 dB(A)).



Lifting instructions.

IMPORTANT: gear reducers and gearmotors supplied by Rossi are **partly completed machinery** to be incorporated into machinery and **should not be commissioned before the machinery in which the components have been incorporated conforms to:**

- **Machinery directive 2006/42/EC and subsequent updates; in particular, possible safety guards for shaft ends not being used for eventually accessible fan cover passages (or other) are the Buyer's responsibility;**
- **«Electromagnetic compatibility (EMC)» 2004/108/EC and subsequent updates.**



Attention! It is recommended to pay attention to all instructions of present handbook, all standards concerning correct installation and all existing safety laws. Whenever personal injury or property damage may occur, foresee adequate supplementary protection devices against:

- **release or breakage of fastening screws;**
- **rotation or unthreading of the gear reducer from shaft end of driven machine following to accidental breakage of the reaction arrangement;**
- **accidental breakage of shaft end of driven machine.**

If deviations from normal operation occur (temperature increase, unusual noise, etc.) immediately switch off the machine.

Installation

An incorrect installation, an improper use, the removing or disconnection of protection devices, the lack of inspections and maintenance, improper connections may cause severe personal injury or property damage. Therefore the component must be moved, installed, commissioned, handled, controlled, serviced and re-paired **exclusively by responsible qualified personnel.**

The qualified personnel must be **specifically instructed** and have the experience necessary to **recognize** and prevent **dangers** (see table 1.2.1 - Residual dangers) connected to present products avoiding all possible emergencies.

Gear reducers and gearmotors of present handbook are normally suitable for installations in **industrial areas**: additional protection measures, if necessary, must be adopted and assured by the personnel responsible for the installation.

Attention! Components in non-standard design or with special executions or with constructive variations may differ in the details from the ones described here following and may require additional information.

Attention! For the installation, use and maintenance of the **electric motor** (standard, brake or non-standard motor) or of the eventual motor variator and/or electric supply device (frequency converter, soft-start etc.), and/or optional electric devices (e.g.: independent cooling unit, etc.), consult the attached specific documentation. If necessary, require it.

Maintenance

When operating on gear reducer or on components connected to it the **machine** must be **at rest and cold**: disconnect motor (including auxiliary equipments) from power supply, gear reducer from load, be sure that safety systems are on against any accidental starting and, if necessary, pre-arrange mechanical locking devices (to be removed before commissioning).



Attention! During the running the gear reducers could have **hot surfaces**; always wait that the gear reducer or the gearmotor to cool before carrying out any operations.

Please download further technical documentation (e.g.: catalogs) from our website www.rossi-group.com or contact Rossi. For any clarification and/or additional information consult Rossi and specify all name plate data.

Tab. 1.2.1 - Residual risks

The products supplied by Rossi S.p.A. have been designed and manufactured according to the essential health and safety requirements provided for by the Machine Directive 2006/42/EC - Annex I. The following table lists the residual risks that the user must deal with in compliance with the instructions contained in this document and in those eventually attached to the shipment.

Nature/Cause of Risk	Countermeasures
Installation and maintenance operations	<p>The component must be handled, installed, commissioned, operated, inspected, maintained, and repaired only by qualified, responsible personnel who must carefully read and strictly follow all instructions in this document, including any instructions enclosed with the shipment. They shall also be specifically instructed and have the necessary experience to recognize the hazards and potential hazards (electrical or mechanical) associated with these products, such as, but not limited to:</p> <ul style="list-style-type: none"> - presence of electrical voltage; - presence of temperature higher than 50 °C; - presence of moving parts during operation; - presence of suspended loads; - presence of possible high sound level (> 85 dB (A)). <p>It must be equipped with appropriate personal protective equipment (PPE) and be familiar with and comply with all applicable regulations regarding proper installation and current safety laws in order to ensure the safety of persons and avoid significant damage to the machine or system.</p>
Falling or projecting objects	<p>For gearboxes equipped with a backstop, provide a protection system against the projection of objects resulting from the breaking of the backstop.</p> <p>For gearboxes fitted with a coupling (fast and/or slow shaft), provide protection against the projection of objects resulting from breakage of the coupling itself.</p> <p>For shaft-mounted gear units, provide appropriate safety devices against</p> <ul style="list-style-type: none"> - Loosening or breaking of the mounting screws; - Rotation or loosening of the gear unit from the machine pin due to accidental breakage of the reaction constraint; - accidental breakage of the machine pin.
Movable elements	<p>Provide safety guards for unused shaft ends and accessible fan cover passages (or other).</p> <p>Any work on the gearbox or gearmotor must be carried out with the machine stopped and disconnected from the power supply and the gearbox or gearmotor cold.</p>
Extreme Temperatures	<p>During operation, the gearboxes may have hot surfaces (> 50 °C); before starting any operation, always wait for the gearbox or gearmotor to cool down (wait about 1 to 3 hours depending on the size); if necessary, carry out a temperature measurement on the surface of the gearbox or gearmotor near the fast shaft. The same applies to the hydraulic coupling, if present.</p> <p>After a period of operation, the gearbox is subjected to a slight internal overpressure that can result in the leakage of burning fluid.</p> <p>Therefore, before loosening the caps (of any kind) wait for the gearbox to cool down; otherwise, use appropriate protection (PPE) against burns resulting from accidental contact with hot oil.</p> <p>In any case, always proceed with the utmost caution.</p>
Noise	<p>Depending on the size, gear ratio, gearbox, type of service, and mounting system of the gearbox or gearmotor, the noise emission level may exceed 85 dB(A). Perform field measurements and, if necessary, equip the personnel concerned with appropriate personal protective equipment (PPE).</p>
Changes that may affect the safety of the equipment	<p>Do not make any structural modification to the products supplied by Rossi (reducers, gearmotors, control group, etc.) without prior approval by Rossi S.p.A.</p>
Use of substitute components with characteristics not suitable for the application	<p>Spare parts must be those authorized by Rossi S.p.A.</p>

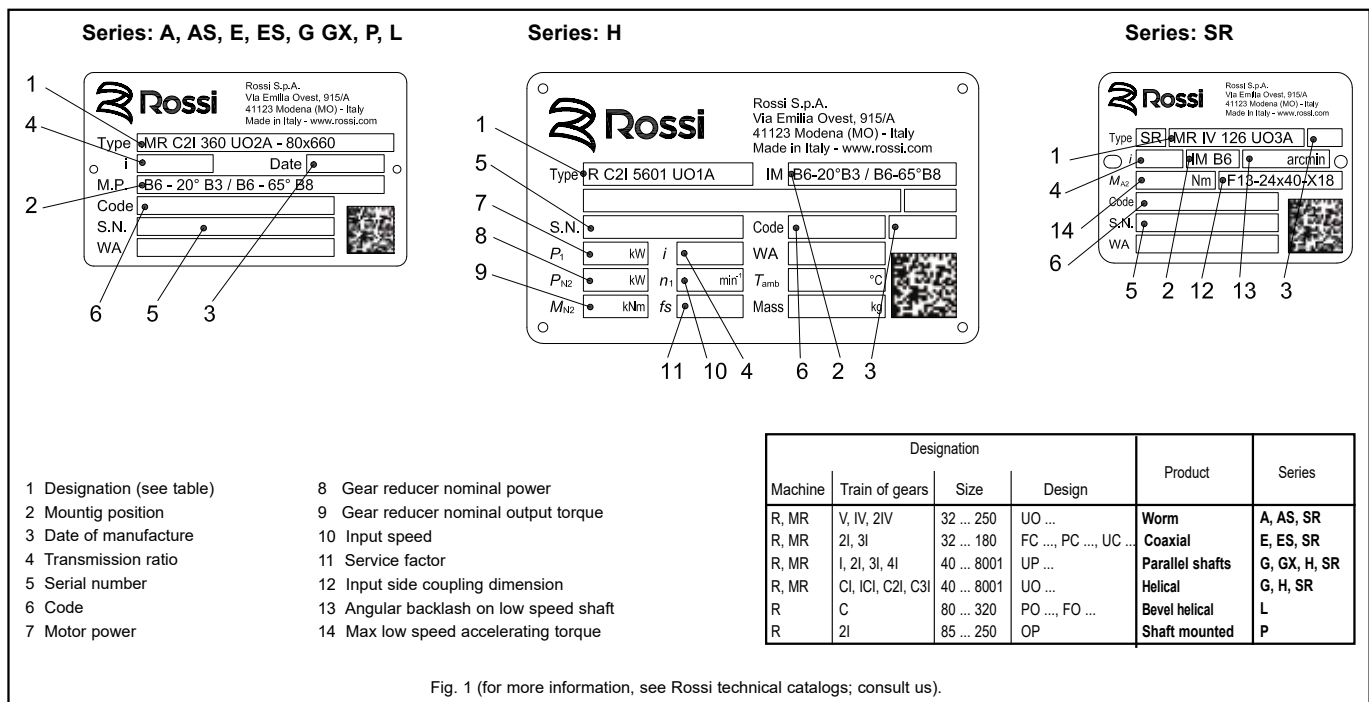

Note: Starting from 04/05/2010 the company name ROSSI MOTORIDUTTORI S.p.A. has been changed into Rossi S.p.A., and the nameplates have been updated accordingly.

2 - Operating instructions

Gear reducers are designed for industrial applications according to name plate data, at ambient temperature $0 \div +40 \text{ }^\circ\text{C}$ (with peaks at $-10 \text{ }^\circ\text{C}$ and $+50 \text{ }^\circ\text{C}$), maximum altitude 1 000 m.

Not allowed running conditions: application in aggressive environments having explosion danger, etc. Ambient conditions must comply with specifications stated on name plate.

3 - How supplied

3.1 - Receipt

At receipt verify that the unit corresponds to the one ordered and has not been damaged during the transport, in case of damages, report them immediately to the courier.

Avoid commissioning gear reducers and gearmotors, that are even if slightly damaged.

3.2 - Name plate

Every gear reducer presents a name plate in anodised aluminium containing main technical information relevant to operating and constructive specifications and defining, according to contractual agreements, the application limits (see fig. 1); the name plate must not be removed and must be kept integral and readable. All name plate data must be specified on eventual spare part order.

3.3 - Painting

Products are painted according to the painting table shown on page 24.

Before adding further coats of paint (use dual-compound paints only), properly protect the seal rings (which must neither be damaged nor painted), degrease and sand the gear reducer (or gearmotor) surfaces.

3.4 - Protections and packing

Overhanging free shaft ends and hollow shafts are treated with protective anti-rust long life oil and protected with a plastic (polyethylene) cap (only up to $D \leq 48 \text{ mm}$ for overhanging shafts, $D \leq 110 \text{ mm}$ for hollow shafts). All internal parts are protected with protective anti-rust oil.

Unless otherwise agreed in the order, products are adequately packed: on pallet, protected with a polyethylene film, wound with adhesive tape and strap (bigger sizes); in carton pallet, wound with adhesive tape and strap (smaller sizes); in carton boxes wound with tape (for small dimensions and quantities). If necessary, gear reducers are conveniently separated by means of anti-shock foam cells or of filling cardboard.

Do not stock packed products on top of each other.

4 - Storing

Surroundings should be sufficiently clean, dry and free from excessive vibrations ($v_{\text{eff}} \leq 0,2 \text{ mm/s}$) to avoid damage to bearings (excessive vibration should also be guarded during transit, even if within wider range) and ambient storage temperature should be $0 \div +40 \text{ }^\circ\text{C}$: peaks of $10 \text{ }^\circ\text{C}$ above and below are acceptable.

The gear reducers filled with oil must be positioned according to the mounting position mentioned on the order during transport and storage.

Every six months rotate the shafts (some revolutions are sufficient) to prevent damage to bearings and seal rings.

Assuming normal surroundings and the provision of adequate protection during transit, the unit is protected for storage up to 1 year.

For a 2 year storing period in normal surroundings it is necessary to pay attention also to following instructions:

- generously grease the sealings, the shafts and the unpainted machined surfaces, if any, and periodically control conservation state of the protective anti-rust oil;
- for gear reducers and gearmotors supplied without oil: completely fill the gear reducers with lubrication oil and verify the specified level before commissioning.

For storages longer than 2 years or in aggressive surroundings or outdoors, consult Rossi.

5 - Installation

5.1 - General

Before the installation, verify that:

- there were no damages during the storing or the transport;
- design is suitable to the environment (temperature, atmosphere, etc.);
- electrical connection (power supply, etc.) corresponds to motor name plate data;
- used mounting position corresponds to the one stated in name plate.



Attention! When lifting and transporting the gear reducer or gearmotor use through holes or tapped holes of the gear reducer housing; be sure that load is properly balanced and provide lifting systems, and cables of adequate section. If necessary, gear reducer and gearmotor masses are stated in Rossi technical catalogs.

Be sure that the structure on which gear reducer or gearmotor is fitted is plane, levelled and sufficiently dimensioned in order to assure fitting stability and vibration absence (vibration speed $v_{\text{eff}} \leq 3,5$ mm/s for $P_N \leq 15$ kW and $v_{\text{eff}} \leq 4,5$ mm/s for $P_N > 15$ kW are acceptable), keeping in mind all transmitted forces due to the masses, to the torque, to the radial and axial loads.

For the dimensions of fixing screws of gear reducer feet and the depth of tapped holes consult the Rossi technical catalogues.

Carefully select the length of fastening bolts when using tapped holes for gear reducer fitting, in order to assure a sufficient meshing thread length for the correct gear reducer fitting to the machine without breaking down the threading seat.



Attention! Bearing life and good shaft and coupling running depend on alignment precision between the shafts. Carefully align the gear reducer with the motor and the driven machine (with the aid of shims if need be, for gear reducers size ≥ 400 use level tapped holes), interposing flexible couplings whenever possible.

Incorrect alignment may cause **breakdown of shafts and/or bearings** (which may cause overheatings) which may represent **heavy danger for people**.

Do not use motor eyebolts when lifting the gearmotors.

Position the gear reducer or gearmotor so as to allow a free passage of air for cooling both gear reducer and motor (especially at their fan side).

Avoid: any obstruction to the air flow; heat sources near the gear reducer that might affect the temperature of cooling air and of gear reducer (for radiation); insufficient air recycle and applications hindering the steady dissipation of heat.



Mount the gear reducer or gearmotor so as not to receive vibrations.

Place the supplied adhesive pictogram identifying the risk associated with hot surfaces on the surface of the gear unit in a position visible to personnel involved in machine operation and maintenance.

Mating surfaces (of gear reducer and machine) must be clean and sufficiently rough to provide a good friction coefficient (indicatively $Ra\ 3,2 \div 6,3\ \mu\text{m}$). Remove by a scraper or solvent the eventual paint of gear reducer coupling surfaces

When external loads are present use pins or locking blocks, if necessary.

When fitting gear reducer and machine and/or gear reducer and eventual flange B5 it is recommended to use **locking adhesives** such on the fastening screws (also on flange mating surfaces).

For accessories not supplied by Rossi, pay attention to their dimensioning; consult us, if need be.

Before wiring-up the gearmotor make sure that motor voltage corresponds to input voltage. If direction of rotation is not as desired, invert two phases at the terminals.

Y- Δ starting should be adopted for no-load starting (or with a very small load) and for smooth starts, low starting current or other similar devices should be fitted.

If overloads are imposed for long periods or if shocks or danger of jamming are envisaged, then motor-protection, electronic torque limiters, fluid couplings, safety couplings, control units or other similar devices should be fitted.

Usually protect the motor with a thermal cut-out however, where duty cycles involve a high number of on-load starts, it is necessary to utilise **thermal probes** for motor protection (fitted on the wiring); magnetothermic breaker is unsuitable since its threshold must be set higher than the motor nominal current of rating.

Connect thermal probes, if any, to auxiliary safety circuits.

Use varistors and/or RC filters to limit voltage peaks due to contactors.

For gear reducers equipped with backstop device (see ch. 5.12), foresee a protection system where a backstop device breaking could cause personal injury or property damage.

Whenever a leakage of lubricant could cause heavy damages, increase the frequency of inspections and/or envisage appropriate control devices (e.g.: remote level gauge, etc.).

In polluting surroundings, take suitable precautions against lubricant contamination through seal rings or other.

For outdoor installation or in a hostile environment (corrosivity class C3 according to ISO 12944-2) protect the gear reducer or gearmotor with a proper anti-corrosion paint (see ch. 3.4), using water-repellent grease (especially around the rotary seating of seal rings and the accessible zones of shaft end).

Gear reducers and gearmotors should be protected whenever possible and by appropriate means from solar radiation and extremis of weather; weather protection **becomes essential** when high or low speed shafts are vertically disposed or when the motor is installed vertical with fan uppermost.

For ambient temperature greater than +40 °C or less than 0 °C, consult Rossi.

When gear reducer or gearmotor is supplied with water cooling by coil or independent cooling unit, see ch. 7.

5.2 - Fitting of components to shaft ends

It is recommended that the holes of parts keyed onto shaft ends should be machined to H7 tolerance; for high speed shaft ends having $D \geq 55$ mm, tolerance G7 is permissible provided that the load is uniform and light; for low speed shaft end having $D \leq 180$ mm, tolerance must be **K7** if load is not uniform and light.

Before mounting, thoroughly clean mating surfaces and lubricate against seizure and fretting corrosion.

Attention! Installing and removal operations should be carried out with the aid of **jacking screws** and **pullers** using the tapped hole at the shaft butt-end (see table in fig. 2) taking care to avoid impacts and shocks which may **irremediably damage** the **bearings**, the **circlips** or other parts, for H7/m6 and K7/j6 fits it is advisable that the part to be keyed is preheated to a temperature of $80 \div 100$ °C.

Shaft ends	
D Ø	d Ø
11	M 5
14 ÷ 19	M 6
24 ÷ 28	M 8
30 ÷ 38	M 10
42 ÷ 55	M 12
60 ÷ 75	M 16
80 ÷ 95	M 20
100 ÷ 110	M 24
125 ÷ 140	M 30
160 ÷ 210	M 36
240 ÷ 320	M 45

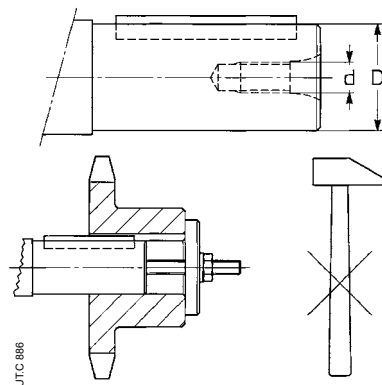

Fig. 2

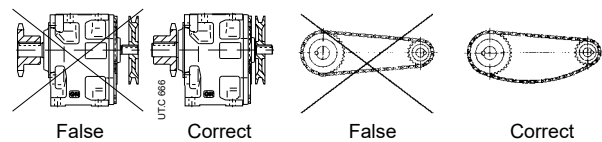

Fig. 3

The couplings having a tip speed on external diameter up to 20 m/s must be statically balanced; for higher tip speeds they must be dynamically balanced.

Where the transmission link between gear reducer and machine or motor generates shaft end loads, (see fig. 3), ensure that:

- loads do not rise above catalog values;
- transmission overhang is kept to a minimum;
- gear-type transmissions must guarantee a minimum of backlash on all mating flanks;
- drive-chains should not be tensioned (if necessary — alternating loads and/or motion — foresee suitable chain tighteners);
- drive-belts should not be over-tensioned.

5.3 - Shaft mounting

When shaft mounted, the gear reducer must be supported both axially and radially (also for mounting positions B3 ... B8) by the machine shaft end, as well as anchored against rotation only, by means of a reaction having **freedom of axial movement** and sufficient **clearance in its couplings** to permit minor oscillations always in evidence without provoking dangerous overloading on the gear reducer.

Lubricate with proper products the hinges and the parts subject to sliding; when mounting the screws it is recommended to apply **locking adhesives**.

For the mounting of the "kit using reaction disc springs" (sizes ≤ 125 helical gear units) use the tapped butt end hole on the shaft end of the driven machine and the flat machined chamfered surface for compressing and fitting the disc springs into the reaction recess.

Concerning the reaction system, follow the project indications stated in the technical catalogs Rossi. Whenever personal injury or property damage may occur, foresee **adequate supplementary protection devices** against:

- rotation or unthreading of the gear reducer from shaft end of driven machine following to accidental breakage of the reaction arrangement;
- accidental breakage of shaft end of driven machine.

5.4 - Hollow low speed shaft

For machine shaft ends onto which the hollow shafts of gear reducers are to be keyed, h6, j6, and k6 tolerances are recommended, according to requirements.

Important! The shoulder diameter of the shaft end of the driven machine abutting with the gear reducer must be at least $1,18 \div 1,25$ times the internal diameter of hollow shaft. For other data on machine shaft end, in case of standard hollow low speed shaft, stepped shaft, with locking rings or bush, with shrink disc see Rossi technical catalogs.

Attention! For **vertical ceiling-type** mounting and only for gear reducers equipped with locking rings or bush, gear reducer support is due only to friction, for this reason it is advisable to provide it with a fastening system.

When **installing** and **removing** gear reducers and gearmotors with hollow low speed shaft incorporating a circlip groove — whether with keyway or shrink disc — proceed as per fig. 4a and 4b, respectively, on page 14.

Warning. Even if low speed shafts are principally machined within H7 tolerance, a check using a plug could detect two areas with **slightly smaller diameters** (see Fig. 5a): this reduction is intentional and does not affect the **quality of keying** - which in fact will be **improved** in terms of **duration** and **precision** - and it does not represent an obstacle to the assembly of a machine shaft end executed according to the usual methods, such as to the one shown on Fig. 4a.

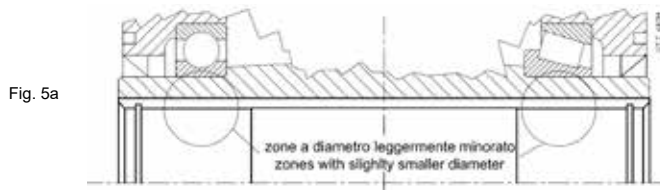

In order to remove the hollow low speed shaft of the helical and bevel helical gear reducers (this is the first operation to perform when disassembling the gear reducer) turn the shaft until the keyway is facing the intermediate shaft as indicated in fig. 5b and push the shaft from the reference groove side (circumferential keyway on shaft shoulder).

The system shown in fig. 4c and 4d, page 14, is good for **axial fastening**; when the shaft end of the driven machine has no shoulder (as in the lower half of the drawing) a spacer may be located between the circlip and the shaft end itself. Parts in contact with the circlip must have sharp edges.

The use of **locking rings** (fig. 4e, page 14) or **locking bush** (fig. 4f page 14) will permit easier and more accurate installing and removing and eliminate backlash between the key and keyway.

The locking rings or bush are fitted after mounting and after having carefully degreased the coupling surfaces. Do not use molybdenum bisulphide or equivalent lubricant for the lubrication of the parts in contact. When tightening the bolt, we recommend the use of a **locking adhesive**.

Respect the tightening torques stated in the table on page 24.

In case of axial fastening with locking rings or bush – especially when having heavy duty cycles, with frequent reversals – verify, after some hours of running, the bolt tightening torque and eventually apply the locking adhesive again.

When fitting with **shrink disc** (fig. 4g, page 14) proceed as follows:

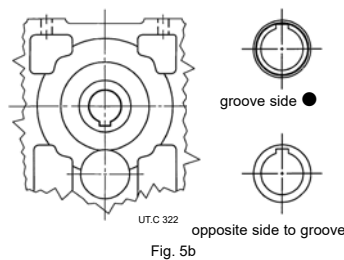

- carefully degrease the surfaces of hollow shaft and shaft end of driven machine to be fitted;
- mount the gear reducer onto the shaft end of driven machine following the method indicated in fig. 4a, page 14;
- gradually and uniformly tighten the screws of shrink disc by a continuous sequence (not crossing) and during several phases up to a torque stated in the table on page 24;
- at operation end verify the screw tightening torque by means of a dynamometric key (flat, when it is mounted onto machine end).

5.5 - Backstop device

The presence on gear reducer of backstop device is stated by the arrow near the low speed shaft, indicating the free rotation, excluding the shaft mounted gear reducers for which B or C design is stated (see Rossi technical catalogs).

Provide a protection system where a backstop device breaking could cause personal injury or property damage.

Check - before starting - that there is **correspondence between free rotation and the direction of rotation of the machine to be driven and of the motor**.



Attention! One or more startings in the false direction, even if short, could irretrievably damage the backstop device, the coupling seats and/or the electric motor.

5.6 Shrink disc

Installation

- Carefully degrease the surfaces of hollow shaft and shaft end of driven machine to be fit;
- mount the shrink disc on gear reducer hollow shaft by lubricating first only the external surface of hollow shaft;
- slightly tighten a first group of three screws positioned at about 120°;
- mount the gear reducer on machine shaft end;
- gradually and uniformly tighten, by means of dynamometric wrench, the screws of shrink disc at torque value 5% higher than the one shown in the table at page 24, by a continuous sequence (not crossing) using approximately 1/4 turns for each pass until 1/4 turn can no longer be achieved;
- continue to apply overtorque by means of dynamometric wrench for 1 or 2 more passes and at the end verify that the tightening torque stated in the table has been achieved;
- when having heavy duty cycles, with frequent reversals, verify again after some hours of running, the bolt tightening torque.

Removal

- Prior to initiating the removal procedure, check that no torque or thrust loads are acting on the shrink disc, shaft or any mounted components;
- clean off any rusty areas;
- loosen the fastening screws one after the other only by using approx. 1/2 turn at a time and by a continuous sequence (not crossing), until shrink disc can be moved on hollow shaft;
- do not completely remove fastening screws before locking rings are disengaged: risk of serious injury!
- remove the gear reducer from the machine shaft.

6.2 - Lubrication table

Product	How supplied* and plugs	Directions for first filling																																																												
Worm sizes 32 ... 81	FILLED WITH SYNTHETIC OIL AGIP Blasias S 320, KLÜBER Klübersynth GH 6-320, MOBIL Glygoyle HE 320, SHELL Omala S4 WE 320 Worm speed $\leq 280 \text{ min}^{-1}$ KLÜBER Klübersynth GH6-680, MOBIL Glygoyle HE 680, SHELL Omala S4 WE 680 Filler plug 1 filler plug sizes 32 ... 64 Filler/drain plug 2 filler/drain plugs for sizes 80, 81	Directions for first filling																																																												
Worm sizes 100 ... 250	WITHOUT OIL (except different statement on lubrication name plate) Filler plug with valve, drain and level plug FILLED WITH SYNTHETIC GREASE SHELL Gadus S5 V142W00, IP Telesia Compound A, MOBIL Glygoyle Grease 00 Filler/drain plug (only for coaxial) FILLED WITH SYNTHETIC OIL KLÜBER Klübersynth GH 6-220, MOBIL Glygoyle 30, SHELL Omala S4 WE 220	Before putting into service, fill to specified level with synthetic oil (AGIP Blasias S, ARAL Degol GS, BP-Energol SG-XP, MOBIL Glygoyle, SHELL Omala S4 WE ..., KLÜBER Klübersynth GH6...) having the ISO viscosity grade given in the table. ISO viscosity grade [cSt] <table border="1"> <thead> <tr> <th rowspan="3">Worm speed min^{-1}</th> <th colspan="6">Ambient temperature $0 \div +40 \text{ }^\circ\text{C}^{2)}$</th> </tr> <tr> <th colspan="6">Gear reducer size</th> </tr> <tr> <th>100</th> <th colspan="2">125 ... 161</th> <th colspan="2">200, 250</th> </tr> <tr> <td></td> <td>B3¹⁾, V5, V6</td> <td>B6, B7, B8</td> <td>B3¹⁾, V5, V6</td> <td>B6, B7, B8</td> <td></td> <td></td> </tr> </thead> <tbody> <tr> <td>2 800 \div 1 400³⁾</td> <td>320</td> <td>320</td> <td>220</td> <td></td> <td>220</td> <td></td> </tr> <tr> <td>1 400 \div 710³⁾</td> <td>320</td> <td>320</td> <td></td> <td>320</td> <td>220</td> <td></td> </tr> <tr> <td>710 \div 355³⁾</td> <td>460</td> <td>460</td> <td></td> <td>460</td> <td>320</td> <td></td> </tr> <tr> <td>355 \div 180³⁾</td> <td>680</td> <td>680</td> <td>460</td> <td></td> <td>460</td> <td></td> </tr> <tr> <td>< 180</td> <td>680</td> <td>680</td> <td></td> <td></td> <td>680</td> <td></td> </tr> </tbody> </table> <p>1) Not stated on the name plate. 2) Peaks of $10 \text{ }^\circ\text{C}$ above and $10 \text{ }^\circ\text{C}$ ($20 \text{ }^\circ\text{C}$ for $\leq 460 \text{ cSt}$) below the ambient temperature range are acceptable. 3) For these speeds we advise to replace oil after running-in.</p>	Worm speed min^{-1}	Ambient temperature $0 \div +40 \text{ }^\circ\text{C}^{2)}$						Gear reducer size						100	125 ... 161		200, 250			B3 ¹⁾ , V5, V6	B6, B7, B8	B3 ¹⁾ , V5, V6	B6, B7, B8			2 800 \div 1 400 ³⁾	320	320	220		220		1 400 \div 710 ³⁾	320	320		320	220		710 \div 355 ³⁾	460	460		460	320		355 \div 180 ³⁾	680	680	460		460		< 180	680	680			680	
Worm speed min^{-1}	Ambient temperature $0 \div +40 \text{ }^\circ\text{C}^{2)}$																																																													
	Gear reducer size																																																													
	100	125 ... 161		200, 250																																																										
	B3 ¹⁾ , V5, V6	B6, B7, B8	B3 ¹⁾ , V5, V6	B6, B7, B8																																																										
2 800 \div 1 400 ³⁾	320	320	220		220																																																									
1 400 \div 710 ³⁾	320	320		320	220																																																									
710 \div 355 ³⁾	460	460		460	320																																																									
355 \div 180 ³⁾	680	680	460		460																																																									
< 180	680	680			680																																																									
Coaxial sizes 32 ... 41 Right angle shaft (cat. L) sizes 80 ... 125	Filler/drain plug (only for coaxial)																																																													
Coaxial sizes 50 ... 81 Helical and bevel helical sizes 40 ... 81	Filler/drain plug 2 filler/drain plugs for sizes 80, 81																																																													
Coaxial sizes 100 ... 180 Helical and bevel helical sizes 100 ... 8001 Right angle shaft (cat. L) sizes 160 ... 320 Shaft mounted	WITHOUT OIL** (except different statement on lubrication name plate) Filler plug with valve (with breathing for shaft mounted gear reducers), drain and level plugs	Before putting into service, fill to specified level with mineral oil (AGIP Blasias, ARAL Degol BG, BP-Energol GR-XP, IP Mellana oil, MOBIL Mobilgear 600 XP, SHELL Omala S2 G, TEXACO Meropa, TOTAL Carter EP) or polyglycol** synthetic oil (KLÜBER Klübersynth GH6 ..., MOBIL Glygoyle, SHELL Omala S4 WE) or polyalphaolefines** synthetic oil (AGIP Blasias SX, CASTROL Alphasyn EP, ELF Reductelf SYNTHESE, SHELL Omala S4 GX, KLÜBER Klübersynth GEM4, MOBIL SHC Gear) having the ISO viscosity grade given in the table. Mean kinematic viscosity [cSt] at $40 \text{ }^\circ\text{C}$. <table border="1"> <thead> <tr> <th rowspan="3">Speed n_2 min^{-1}</th> <th colspan="6">Ambient temperature¹⁾ [$^\circ\text{C}$]</th> </tr> <tr> <th colspan="2">mineral oil</th> <th colspan="4">synthetic oil</th> </tr> <tr> <th colspan="2">2)</th> <th colspan="2">2)</th> <th colspan="2">2)</th> </tr> <tr> <td>Right angle Shafts (L)</td> <td>Others</td> <td>-20 \div 0</td> <td>0 \div 20</td> <td>20 \div 40</td> <td>-20 \div 0</td> <td>0 \div 40</td> </tr> </thead> <tbody> <tr> <td>> 710</td> <td>> 224</td> <td>150</td> <td>150</td> <td>150</td> <td>150</td> <td>150</td> </tr> <tr> <td>710 \div 280</td> <td>224 \div 22,4</td> <td>150</td> <td>150</td> <td>220</td> <td>150</td> <td>220</td> </tr> <tr> <td>280 \div 90</td> <td>22,4 \div 5,6</td> <td>150</td> <td>220</td> <td>320</td> <td>220</td> <td>320</td> </tr> <tr> <td>< 90</td> <td>< 90</td> <td>220</td> <td>320</td> <td>460</td> <td>320</td> <td>460</td> </tr> </tbody> </table> <p>1) Peaks of $10 \text{ }^\circ\text{C}$ ($20 \text{ }^\circ\text{C}$) below and $10 \text{ }^\circ\text{C}$ above the ambient temperature range are acceptable. 2) For size ≥ 4001 only.</p>	Speed n_2 min^{-1}	Ambient temperature ¹⁾ [$^\circ\text{C}$]						mineral oil		synthetic oil				2)		2)		2)		Right angle Shafts (L)	Others	-20 \div 0	0 \div 20	20 \div 40	-20 \div 0	0 \div 40	> 710	> 224	150	150	150	150	150	710 \div 280	224 \div 22,4	150	150	220	150	220	280 \div 90	22,4 \div 5,6	150	220	320	220	320	< 90	< 90	220	320	460	320	460						
Speed n_2 min^{-1}	Ambient temperature ¹⁾ [$^\circ\text{C}$]																																																													
	mineral oil			synthetic oil																																																										
	2)		2)		2)																																																									
Right angle Shafts (L)	Others	-20 \div 0	0 \div 20	20 \div 40	-20 \div 0	0 \div 40																																																								
> 710	> 224	150	150	150	150	150																																																								
710 \div 280	224 \div 22,4	150	150	220	150	220																																																								
280 \div 90	22,4 \div 5,6	150	220	320	220	320																																																								
< 90	< 90	220	320	460	320	460																																																								

Independently-lubricated bearings, motor-bearings, backstop device fitted to motor:

lubrication is «for life» (except some cases of motors in which relubrication device is adopted). Should there be either a possibility of the grease becoming contaminated, or a very heavy type of duty-cycle, it is good policy to check on the state of the grease (between one change and the next, or every year or 2 years) and remove and replace grease in independently-lubricated bearings (every change or every other change, or every 2 or 4 years). Bearings should be filled with SHELL Gadus S2 V100 bearing-grease for ball bearings, KLÜBER STABURAGS NBU 8 EP for roller bearings; lubricate the backstop device with SHELL Alvania RL2.

Oil-change interval and lubricant quantity

Oil quantity [l] for worm gear reducers sizes 32 ... 81

For the other sizes the quantity is given by the level stated by the proper plug.

Size	R V, MR V			R IV, MR IV			MR 2IV			
	B3 ¹⁾ , V5, V6	B6, B7	B8 ¹⁾	B3 ¹⁾ , V5, V6	B6, B7	B8 ¹⁾	B3 ¹⁾	B6, B7	B8 ¹⁾	V5, V6
32	0,16	0,2	0,16	0,2	0,25	0,2	—	—	—	—
40	0,26	0,35	0,26	0,32	0,4	0,32	0,42	0,5	0,42	0,42
50	0,4	0,6	0,4	0,5	0,7	0,5	0,6	0,8	0,6	0,6
63, 64	0,8	1,15	0,8	1	1,3	1	1,2	1,55	1,2	1,2
80, 81	1,3	2,2	1,7	1,5	2,5	2	1,7	2,8	2,3	1,8

1) Not stated on name plate (B8, only sizes 32 ... 64).
Ambient temperature 0 ÷ +40 °C with peaks up to -20 °C and +50 °C.

An overall guide to **oil-change interval** is given in the table, and assumes pollution-free surroundings. Where heavy overloads are present, halve the values.

Apart from running hours, replace or regenerate the oil each 5 ÷ 8 years according to size, running and environmental conditions.

Oil temperature [°C]	Oil-change interval [h]
≤ 65	18 000
65 ÷ 80	12 500
80 ÷ 95	9 000
95 ÷ 110	6 300

Lubrication «for life» (assuming external pollution-free environment).

Grease quantity [kg] for coaxial gear reducers

Size	R 2I, MR 2I, 3I			
	B3 ¹⁾ , B6, B7, B8	V5, V6	B5 ¹⁾	V1, V3
32	0,14	0,25	0,1	0,18
40, 41	0,26	0,47	0,19	0,35

1) Non stated on name plate
Ambient temperature 0 ÷ +40 °C with peaks up to -20 °C and +50 °C.

Lubrication «for life» (assuming external pollution-free environment). Oil quantity [l] for sizes 50 ... 81

Coaxial size	R 2I, 3I, MR 2I, 3I		
	B3 ¹⁾	B6, B7, B8, V6	V5
50, 51	0,8	1,1	1,4
63, 64	1,6	2,2	2,8
80, 81	3,1	4,3	5,5

1) Not stated on name plate.
2) Values valid for R 2I; for MR 2I the values are respectively: 0,8; 1,2; 2,3.
3) The first reduction stage (the first two for 4I) is lubricated with grease for life.
Ambient temperature 0 ÷ +40 °C with peaks up to -20 °C and +50 °C.

Parallel size	R I			R 2I, MR 2I			R 3I, MR 3I			MR 4I			
	B3 ¹⁾ , B8	B7	B6, V5, V6	B3 ¹⁾ , B8	B6 ²⁾	B7, V5, V6	B3 ¹⁾ , B8	B6	B7, V5 ³⁾ , V6	B3 ¹⁾ , B8	B6	B7, V6	V5 ³⁾
40	—	—	—	0,4	0,9	0,55	0,47	0,7	0,6	—	—	—	—
50	—	—	—	0,6	0,9	0,8	0,7	1,05	0,9	—	—	—	—
63, 64	0,7	0,8	1	0,9	1,4	1,2	1	1,5	1,3	1,1	1,8	1,4	1,3
80	1,2	1,5	1,9	1,5	2,7	2,3	1,7	2,9	2,5	1,9	3,2	2,7	2,5

Right angle size	R CI, MR CI			R ICI, MR ICI				MR C3I			
	B3 ¹⁾ , B6, B7	B8	V5, V6	B3 ¹⁾ , B7	B6	B8	V5, V6	B3 ¹⁾ , B7	B6	B8	V5, V6
40	0,26	0,35	0,3	0,31	0,5	0,4	0,35	—	—	—	—
50	0,4	0,6	0,45	0,45	0,8	0,65	0,5	0,5	0,9	0,7	0,55
63, 64	0,8	1	0,95	1	1,6	1,2	1,15	1,2	1,8	1,4	1,35
80, 81	1,3	2	1,8	1,6	2,7	2,2	2	1,9	3	2,5	2,3

An overall guide to **oil-change interval** is given in the table, and assumes pollution-free surroundings. Where heavy overloads are present, halve the values.

Apart from running hours:

— replace mineral oil each 3 years;

— replace or regenerate synthetic oil each 5 ÷ 8 years according to gear reducer size, running and environmental conditions.

The oil quantity is given by the level stated by the proper plug.

Oil temperature [°C]	Oil-change interval [h]	
	mineral oil	synthetic oil
≤ 65	8 000	25 000
65 ÷ 80	4 000	18 000
80 ÷ 95	2 000	12 500
95 ÷ 110 ¹⁾	—	9 000

1) Values admissible only for parallel, bevel helical and right angle shaft gear reducers (cat. G and L) an for non-continuous duties.

* Identification through specific lubrication name plate.

** Lubrication with synthetic oil (polyglycol basis must be with special internal painting; polyalphaolefines basis is advisable for sizes ≥ 200 and obligatory for sizes ≥ 400). It is always recommended, particularly for: high speed gear reducers, increase of oil-change interval («long life»), increase of the ambient temperature range, increase of the thermal power or decrease of oil temperature.

6 - Lubrication

6.1 - General

Depending on type and size, gear reducers and gearmotors may be grease-lubricated and supplied **FILLED WITH GREASE**, or (synthetic or mineral) oil-lubricated and supplied **FILLED WITH OIL** or **WITHOUT OIL** depending on type and size (see ch. 6.2). When supplying **WITHOUT OIL**, the filling up to specified level (normally stated by means of transparent level plug) is Buyer's responsibility.

Every gear reducer has a **lubrication plate**.

Concerning lubricant type and quantity, gear reducer type, how supplied, plugs, filling instructions, oil-change interval, etc. see lubrication table (6.2).

Be sure that the gear reducer has been mounted in the mounting position foreseen in the order - including inclined mounting positions (e.g.: B3 38° V5) - as stated on the nameplate; when it is not stated, the gear reducer must be mounted in horizontal mounting position B3 or B5 (B3, B8, worm gear reducers size ≥ 64), vertical V1 (for bevel helical gear reducer design with flange FO1...). For oscillatory mounting positions, the gear reducers are equipped with auxiliary nameplate with statement of mounting position and oil quantity to be filled with as well as level check to be executed during the periodical maintenance.

Be sure that for gear reducers and gearmotors size ≥ 100 , the filler plug is provided with a valve (symbol ); otherwise, replace it with the one normally supplied with.

When gear reducer or gearmotor is provided with a **spilway plug** (red colour) fill after unscrewing a.m. plug in order to check the obtained level by oil outlet.

When gear reducer or gearmotor is provided with a **level plug with rod**, fill with oil up to specified level on rod.

When gear reducer or gearmotor is supplied with a level plug (size ≥ 100), the necessary lubricant quantity is that which **reaches a.m. level in center line of plug (gear reducer at rest)** and not the approximate quantity given on the catalog.

Usually bearings are automatically and continuously lubricated (bathed, splashed, through pipes or by a pump) utilising the main gear reducer lubricant. The same applies for backstop devices, when fitted to gear reducers.

In certain gear reducers in vertical mounting positions V1, V3, V5 and V6, and bevel helical gear reducers in horizontal positions B3, B6 and B51 (though not gearmotors in this case, for which the above indications hold good) upper bearings are independently lubricated with a special grease «for life», assuming pollution-free surroundings. The same applies for motor bearings (except some cases in which relubrication device is adopted) and backstop devices when fitted to motors.

Combined gear reducer units. Lubrication remains independent, thus data relative to each single gear reducer hold good.

6.3 - Extruder support lubrication (helical and bevel helical)

The lubrication of **extruder support** is **separate** from the gear reducer, except:

- for designs HA ... HC;
- in presence of the independent cooling unit, if applied to lubricate both the gear reducer and the support.

The **separate lubrication** of extruder support sensibly improves the reliability and real life of the axial bearing; the separation between gear reducer and support is granted by a seal ring.

With separate lubrication, for the extruder support, use polyalphaolephines based synthetic oil (MOBIL SHC Gear, CASTROL Alphasyn EP) with **ISO 680 cSt** viscosity grade.

With **common lubrication** (designs HA ... HC in presence of independent cooling unit, if applied to lubricate both the gear reducer and the support), lubricant ISO viscosity grade must be according to the instructions given in ch. 6.2 «lubrication table» and oil must be polyalphaolephine based synthetic type.

For the filling up of oil of extruder support, see the table below.

For the lubrication of gear reducer refer to ch. 6.2, lubrication table.

Gear reducer size	Lubrication of extruder support	
	Separate lubrication ¹⁾	Joint lubrication ²⁾
125 ... 451	Filling up to the level (of support)	Filling up to the level (of gear red.)

1) Support with metal filler plug with filter and valve, level and draining plug.

2) The level is the one of gear reducer housing..

7 - Cooling system

7.1 - Cooling by fan

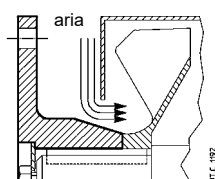

If there is fan on the gear reducer verify that there is sufficient space allowing for adequate circulation of cooling air also after fitting coupling protection. If a coupling protection is fitted (drilled case or wire netting), smooth, the coupling hub, if necessary.

7.2 - Water cooling by coil

The presence of coil is given by water inlets (pipes DIN 2353) protruding from the casing as shown in the following figure.

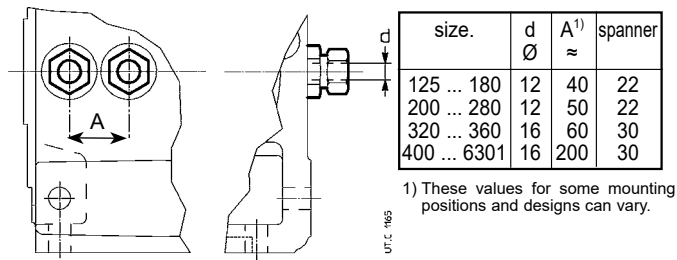

Attention: Do not tamper with the eventual stop plate in order to keep the pipes them locked; in particular keep the pipe locked while tightening the nut of connection pipe. Water fed into the system must:

- be not too hard;
- be at max temperature +20 °C;
- flow at 10 ÷ 20 dm³/min;
- have a pressure 0,2 ÷ 0,4 MPa (2 ÷ 4 bar).

Where ambient temperature may be less than 0 °C, make provision for water drain and compressed air inlet, so as to be able to empty out the coil completely and avoid freezing up.

When risking high input pressure peaks, install a safety valve set to a proper operating threshold.

7.3 - Independent cooling unit

See specific documentation supplied together with the unit.

8 - Commissioning

Carry out an overall check, making particularly sure that the gear reducer is filled with lubricant.

Where star-delta starting is being used, input voltage must match the motor lower voltage (Δ connection).

For asynchronous three-phase motor, if the direction of rotation is not as desired, invert two phases at the terminals.

Before running gear reducers fitted with **backstop device**, see ch. 5.5.

A **running-in** period is advisable:

- of approx. 400 ÷ 1 600 h for gear reducers with worm gear pairs in order to reach maximum efficiency;
- of approx. 200 ÷ 400 h for gear reducers with bevel and/or cylindrical gear pairs in order to reach maximum functionality.

The temperature of both gear reducer and lubricant may well rise beyond normal values during running-in. After the running-in period it may be necessary to verify the gear reducer fastening bolt tightness.

Note: worm gear reducer efficiency is lower in the **first running hours** (about 50) and at every cold starting (efficiency will be better with oil temperature increasing). For further information consult Rossi technical catalogs.

9 - Maintenance

9.1 - General

At machine rest, verify at regular intervals (more or less frequently according to environment and use):

- a) all external surfaces are clean and air passages to the gear reducer or gearmotors are free, in order that cooling remains fully effective;
- b) oil level and deterioration degree (check with cold gear reducer at rest);
- c) the correct fastening screws tightening.

During the operation check:

- noise level;
- vibrations;
- seals;
- etc.

Attention! After a running period, gear reducer is subject to a light internal overpressure which may cause burning liquid discharge. Therefore, before loosening whichever plug wait until gear reducer has become cold; if not possible, take the necessary protection measures against burning due to warm oil contact. In all cases, always proceed with great care.

Maximum oil temperatures indicated in lubrication table (see ch.6.2) do not represent a hindrance to the gear reducer regular running.

Oil change. Execute this operation at machine rest and cold gear reducer.

Prearrange a proper drain oil collection, unscrew both the drain plug and the filler plug in order to facilitate oil draining; dispose the exhaust lubricant in compliance with the laws in force.

Wash the inside part of gear reducer housing using the same oil type suitable for the running; the oil used for this wash can be applied for further washings after proper filtering by 25 µm of filtration standard.

Fill in the gear reducer again up to level.

It is always recommended to replace the seal rings (see ch. 9.3)

When dismantling the cap (whenever gear reducers are provided with), reset the sealing with adhesive on cleaned and degreased mating surfaces.



9.2 - Coil

In case of long non-running periods at ambient temperatures lower than 0 °C, the coil should be emptied out using compressed air to blast out all the coolant, so as to avoid freezing-up which would cause the coil to break.

9.3 - Seal rings

It is always recommended that the seal rings are replaced with new ones when they are removed or during periodic checks of gear reducer; in this case, the new ring should be generously greased and positioned so that the seal line does not work on the same point of sliding contact as the previous ring.

Oil seals must be protected against heat radiation, also during the shrink fitting of parts, if applicable.

Duration depends on several factors such as dragging speed, temperature, ambient conditions, etc.; as a rough guide it can vary from 3 150 to 25 000h.

9.4 - IEC motor mounting and dismounting

Gearmotors with motor keyed on hollow high speed shaft of gear reducer:

– **Worm gearmotors MR V**

– **Helical gearmotors MR 2I, MR 3I 140 ... 360**

– **Bevel helical gearmotors MR CI, MR C2I**

- be sure that the mating surfaces are machined under accuracy rating (IEC 60072-1);
- clean surfaces to be fit thoroughly;
- check that the fit-tolerance (push-fit) between hole and shaft end is G7/j6 for $D \leq 28$ mm, F7/k6 for $D \geq 38$ mm;
- lubricate surfaces to be fitted against fretting corrosion.
- when a lowered key is needed, replace the motor key with the one supplied together with the servo gear reducer; if necessary, adjust it accordingly to the motor shaft keyway length; check that there is a clearance of $0,1 \div 0,2$ mm between the top and the bottom of the keyway of the hole. If shaft keyway is without shoulder, lock the key with a pin.

In case of **hub clamp** (helical gearmotors 2I, 3I with motor size ≥ 200) assemble as follows:

- rotate the hub clamp so that the tightening screw head is aligned with one of the input holes present on gear reducer flange, removing first the relevant plugs;
- do not modify the factory setting of hub clamp axial position as this is the best solution in order to reach the maximum tightening effect;
- introduce the motor from the top down to shoulder;
- lock the motor fitting screws or bolts to the gear reducer flange;
- lock the hub clamp screw by means of torque wrench until the tightening torque stated in the tightening torque table (see page 24) is reached (also during this operation it is advisable not to modify the hub clamp axial position);
- screw the hole plugs of gear reducer flange;

For the disassembly please proceed as follows:

- acting on rear motor shaft end, if possible, or disconnecting the gear reducer from machine and acting on gear reducer low speed shaft (with brake motor please keep the brake released) aligning the key hole with the locking screw of hub clamp;
- align the key through hole with the tightening screw of the hub clamp, (trying not to modify the axial position of hub clamp);
- loosen the motor fastening bolts or nuts from gear reducer flange;
- disassemble the motor.

Gearmotors with cylindrical pinion keyed directly into the motor shaft end:

– **Worm gearmotors MR IV, MR 2IV**

– **Helical gearmotors MR 3I 40 ... 125, MR 4I**

– **Bevel helical gearmotors MR ICI, MR C3I**

– **Coaxial gearmotors**

- be sure that the motor mating surfaces are machined under accuracy rating (IEC 60072-1);
- clean surfaces to be fitted thoroughly;
- check that the fit-tolerance (standard locking) between hole and shaft end is K6/j6 for $D \leq 28$ mm, and J6/k6 for $D \geq 38$ mm;
- when a lowered key is needed, replace the motor key with the one supplied together with the servo gear reducer; if necessary, adjust it accordingly to the motor shaft keyway length; check that there is a clearance of $0,1 \div 0,2$ mm between the top and the bottom of the keyway of the hole. If shaft keyway is without shoulder, lock the key with a pin.
- make sure that the motors have bearing location and overhang (distance S) as shown in the table;

Motor size	Min dynamic load capacity		Max dimension 'S' mm
	Front	Rear	
63	450	335	16
71	630	475	18
80	900	670	20
90	1 320	1 000	22,5
100	2 000	1 500	25
112	2 500	1 900	28
132	3 550	2 650	33,5
160	4 750	3 350	37,5
180	6 300	4 500	40
200	8 000	5 600	45
225	10 000	7 100	47,5
250	12 500	9 000	53
280	16 000	11 200	56

- mount onto the motor shaft as follows:
 - **the spacer** pre-heated at **65° C** treating the relevant motor shaft area with **adhesive type LOXEAL 58-14** and checking that between keyway and motor shaft shoulder there is a cylindrical part ground by 1,5 mm at least; pay attention **not to damage the external surface** of spacer;
 - **the key** in the keyway, making sure that a contact length of at least 0,9 times the pinion width is present;
 - **the pinion** pre-heated at **80 ÷ 100 °C**;
 - **the axial fastening system** when foreseen (self locking screw on motor shaft butt-end with washer and spacer or hub clamp with 1 or more dowels, fig. a); for the cases foreseen **without axial fastening** (fig. b), apply **adhesive type LOXEAL 58-14** also on the motor shaft part laying under the **pinion**;
 - in case of axial fastening system with hub clamp and dowels, make sure that they do not overhung from spacer external surface: screw the dowels completely and, if necessary, imprint the motor shaft with a point;
 - grease (with grease type KLÜBER Petamo GHY 133N) the pinion teeth, the seal ring rotary seating and the ring itself, and assemble carefully, **taking care not to damage seal ring lip in case of accidental shock with pinion toothing**.

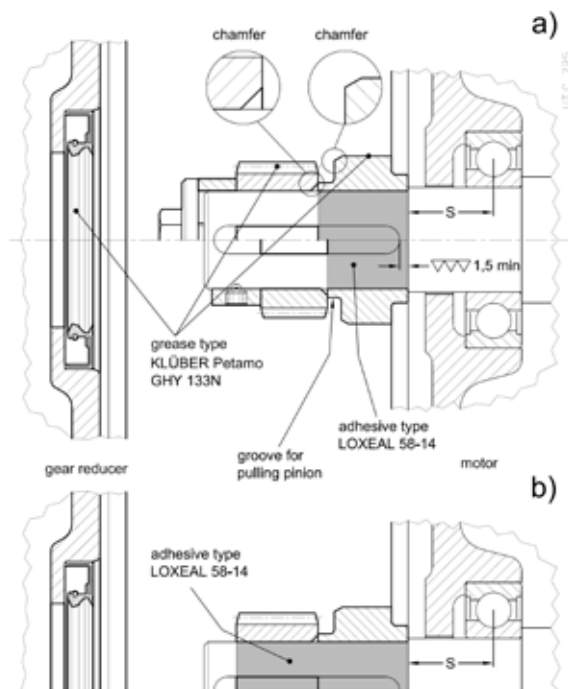

9.5 - Servo motor mounting and dismounting



Attention! Excessive long and heavy motors may cause critical conditions for bending torque and, during running, abnormal vibrations. In these cases, it is advisable to adopt an adequate auxiliary motor mounting system.

Servo gear reducer type MR (servo motor coupling of direct type):

- Worm servo gear reducer MR V
- Helical servo gear reducer MR 2I
- Bevel-helical servo gear reducer MR CI

The servo gear reducer input face has a servo motor mounting flange, **including bolts**, a hollow high speed shaft provided with axial slots and hub clamp.

This kind of fitting can be even **suitable for mounting servo motors with keyless shaft end.**

Prior to installation, thoroughly clean and lubricate the mating surfaces to avoid the risk of seizing and fretting corrosion (see fig. 1).

For the servomotor mounting proceed as follows:

- when a lowered key is needed, replace the key on the servomotor shaft end with the one supplied together with the servo gear reducer; if necessary, adjust accordingly to the servo motor shaft keyway length;
- position the gear reducer vertically with motor mounting flange upwards (see fig. 2);
- rotate the hub clamp so that the tightening screw head is aligned with one of the input holes present on gear reducer flange, removing first the relevant plugs (see fig. 2);
- **do not modify the factory setting of hub clamp axial position** as this is the best solution in order to reach the maximum tightening effect;
- introduce the motor from the top down to shoulder (see fig. 3);
- lock the servomotor fastening bolts or nuts to the servo gear reducer flange;
- lock the hub clamp screw by means of torque wrench until the tightening torque stated in the tightening torque table (at page 24) is reached (also during this operation it is advisable not to modify the hub clamp axial position, see fig. 4);
- screw the hole plugs of gear reducer flange.

Before any motor dismounting be sure that the hub clamp tightening screw has been unloosed, if present.

Servo gear reducer type MR (servo motor coupling of direct type)

- Worm servo gear reducer MR IV
- Coaxial servo gear reducer MR 2I, MR 3I
- Helical servo gear reducer MR 3I
- Bevel-helical servo gear reducer MR ICI

The servo gear reducer input face has a flange (**bolts included**) for servo motor mounting and a helical pinion gear to be fitted onto the servo motor shaft end.

Assembly not possible for servomotors with shaft end without key.

Prior to installation, thoroughly clean and lubricate the mating surfaces to avoid the risk of seizing and fretting corrosion.

For the servo motor mounting proceed as follows:

- check that the fit-tolerance (standard locking) between hole and shaft end is K6/j6 for $D \leq 28$ mm, J6/k6 for $D \geq 38$ mm; the length of the parallel key is to be at least 0,9 times the pinion face width;
- mount onto the servo motor shaft end, in the following order:
 - the **spacer** pre-heated at **65 °C** treating the relevant motor shaft area with **adhesive type LOXEAL 58-14** and checking that between keyway and motor shaft shoulder there is a cylindrical part ground by 1,5 mm at least; pay attention not to **damage the external surface** of spacer;
 - the **key** in the keyway, making sure that a contact length of at least 0,9 times the pinion width is present;
 - the **pinion** pre-heated at **80 ÷ 100 °C**;
 - the **axial fastening system** when foreseen (self locking screw on motor shaft butt-end with washer and spacer or hub clamp with 1 or more dowels, fig. a); for the cases foreseen **without axial fastening** (fig. b), apply adhesive type **LOXEAL 58-14** also on the motor shaft part laying under the **pinion**;
 - in case of axial fastening system with hub clamp and dowels, make sure that they do not overhung from spacer external surface: screw the dowels completely and, if necessary, imprint the motor shaft with a point;

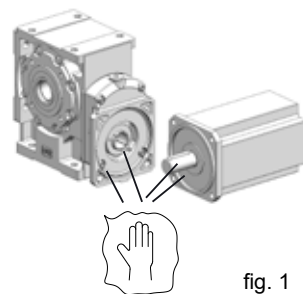

fig. 1

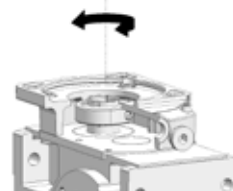

fig. 2

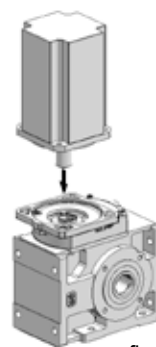

fig. 3

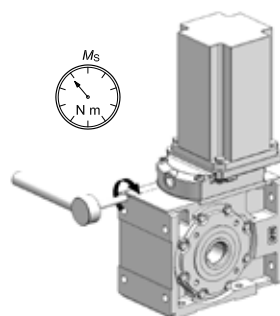
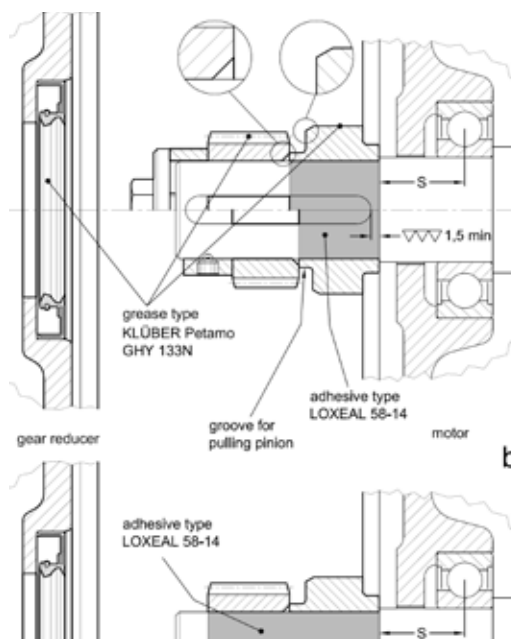

fig. 4



- grease (with grease type KLÜBER Petamo GHY 133N) the pinion teeth, the seal ring rotary seating and the ring itself, and assemble carefully, **paying particular attention not to damage the seal ring lip due to an accidental impact with the pinion toothing.**

Servo gear reducer type R

(servo motor coupling with bell and torsionally stiff coupling)

- Worm servo gear reducer R V, R IV
- Helical servo gear reducer R 2I, R 3I
- Bevel-helical servo gear reducer R CI, R ICI

The servo gear reducer type R input face has a flange (**bolts not included**) for servo motor mounting and a torsionally stiff coupling.

A half-coupling hub is to be fitted onto the servo motor keyless shaft end (if present, remove it; see fig. 1). In case of high starts/hour and heavy loads, it is necessary to request the non-standard design «**Coupling with keyway**».

All mounting surfaces (shafts, bores, keys and keyways), must be clean and free of burrs, nicks and dents.

Check the servo motor shaft diameter, coupling bore diameter, key and keyway dimensions and tolerances.

All coupling bores are machined to tolerance H7.

Assembling clearance between the servo motor shaft diameter and half-coupling hub diameter has to be maintained within 0,01 and 0,05 mm.

A light coating of oil is recommended to ease the mounting process and will not affect the clamping force of the hub.

Do not use molybdenum disulphide or equivalent lubricants.

Insert the half-coupling onto the servo motor shaft, as shown in fig. 1, abutting with elastomer ring seat.

Tighten the clamp screw **E**, using a dynamometric wrench, to the appropriate torque stated in the table¹⁾ (see page 24).

Clean the elastomer ring and the seats into the coupling hubs and apply a light film of oil to facilitate the assembly process, see fig. 2 (use polyurethane compatible lubricants such as e.g. vaseline).

Insert the elastomer ring (fig. 2) and assemble the servo motor on the servo gear reducer, tightening the screws (fig. 3) on the servo motor flange.

The achievement of the zero angular backlash is ensured by the squeezing of the elastomer ring interposed between the two parts of the coupling.

1) In some cases, a spacer to be interposed between the half-coupling and the servo motor shaft shoulder is provided

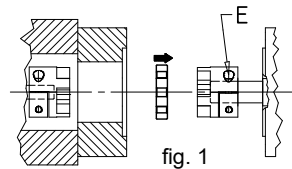

fig. 1

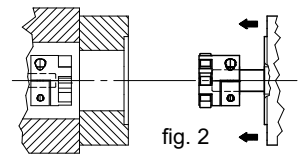

fig. 2

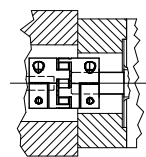

fig. 3

9.6 - Bearings

Since there are many different types of bearings in a gear reducer (roller, tapered roller, straight roller, etc.) and each bearing works with different loads and speeds depending on the input speed, the nature of the load of the driven machine, the transmission ratio, etc., and with different lubricants (oil bath, oil splash, grease, oil circulation, etc.), it is not possible to define any periodical maintenance and replacement of bearings in advance.

If a precautionary maintenance is required, **undertake periodical checks to verify noise level and vibration with the help of appropriate diagnostic equipment and instruments.** If the measured values worsen even slightly it is necessary to stop gear reducer or gear motor and after having inspected inside the unit replace the bearings which are subject to breakdown.

9.7 - Metal filler plug with filter and valve

When the gear reducer or gearmotor (size ≥ 100) is equipped with metal filler plug with filter and valve (see fig. beside), in order to clean it, it is necessary to unscrew it from the gear reducer (preventing any debris or other foreign items from entering the reducer, disassemble the cover, wash it with solvent, dry with compressed air and reassemble it).

This operation is to be made according to environment conditions.

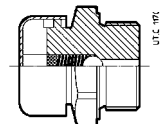

Table of tightening torques fastening bolts (foot, flange, hub clamps and flexible half-coupling bolts)

Bolt	Ms [N m] UNI 5737-88, UNI 5931-84		
	cl. 8.8	cl. 10.9	cl. 12.9
	M4	2,9	4
M5	6	8,5	10
M6	11	15	20
M8	25	35	40
M10	50	70	85
M12	85	120	145
M14	135	190	230
M16	205	290	350
M18	280	400	480
M20	400	560	680
M22	550	770	930
M24	710	1000	1200
M27	1000	1400	1700
M30	1380	1950	2350
M33	2000	2800	3400
M36	2500	3550	4200
M39	2950	4200	5000
M42	4100	5800	6900
M45	5000	7000	8400
M48	6100	8600	10300
M56	9800	13800	16500

Table of tightening torques for plugs

Thread dimension	Ms [N m]
G 1/4"	7
16 MB	14
G 1/2"	14
G 3/4"	14
G 1"	25



Attention! Before tightening, carefully degrease the bolts. For strong vibrations, heavy duties, frequent motion reversals apply a thread-braking seal type Loxeal 23-18 or equivalent.

Note

- Class 8.8 is usually sufficient.
- Before tightening the bolt be sure that the eventual centering of flanges are inserted properly
- The bolts are to be diagonally tightened with the maximum tightening torque.

Gear reducer troubles: causes and corrective actions

Trouble	Possible causes	Corrective actions
Excessive oil temperature	Inadequate lubrication: – excessive or insufficient oil quantity;	Check: – oil level (gear reducer at rest) or quantity
	– unsuitable lubricant (different type, too viscous, exhausted, etc.)	– lubricant type and/or state (see ch. 6.2 lubrication table); replace if necessary
	wrong mounting position	Change mounting position
	Too tightened taper roller bearings	Consult Rossi
	Worm gear reducer with excessive load during running-in	Reduce the load
	Excessive ambient temperature	Increase the cooling or correct the ambient temperature
	Obstructed passage of air	Eliminate obstructive material
	Slow or missing air recycle	Arrange auxiliary ventilation
	Radiance	Screen gear reducer and motor properly
	Inefficiency of auxiliary bearing lubrication system	Check the pump and the pipes
	Worn, faulty or badly lubricated bearings	Consult Rossi
	Inefficient or out of service oil cooling system: obstructed filter, insufficient oil (exchanger) or water (coil) flow rate, pump out of service, water temperature >20 °C, etc.	Check pump, pipes, oil filter and safety devices efficiency (pressure switches, thermostats, flow indicators, etc.)
Anomalous noise	One or more teeth with: – dents or spillings – excessive flanks roughness	Consult Rossi
	Worn, faulty or badly lubricated bearings	Consult Rossi
	Taper roller bearings with excessive clearance	Consult Rossi
	Vibrations	Check the fastening and the bearings
Lubricant leaking from seal rings	Seal ring with worn, bakelized, damaged or false mounted seal lip	Replace seal ring (see ch. 9.3)
	Damaged raceway surface (scoring, rust, dent, etc.)	Restore the raceway
	Mounting position differs from the one stated on the name plate	Position the gear reducer correctly
Oil leaking from filler plug	Too much oil	Check oil level/quantity
	Incorrect mounting position	Check mounting position
	Inefficient vent valve	Clean/replace filler plug with vent valve
Low speed shaft not rotating even with high speed shaft/ motor running	Broken key	Consult Rossi
	Completely worn gear pair	
Lubricant leaking from joints (covers or half-casing joints)	Defective oil seals	Consult Rossi
Water in the oil	Defective cooling coil or heat exchanger	Consult Rossi

Motor: see specific documentation.

NOTE

When consulting Rossi state:

- all data of gear reducer or gearmotor name plate;
- nature and duration of failure;
- when and under which conditions the failure occurred;
- during the warranty period, in order not to lose validity, do not disassemble nor tamper the gear reducer or gearmotor without approval by Rossi.

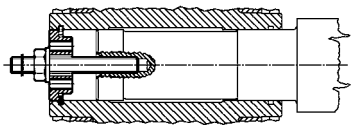

fig. 4a)

Installing fig. 4a) and removing fig. 4b)

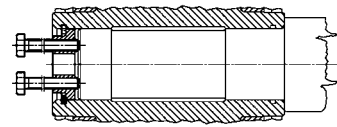

fig. 4b)

Worm sizes
32 ... 50

Helical and bevel helical
size 50

Helical and bevel helical
size MR 3l 50

Worm sizes
63 ... 161

Helical and bevel helical
sizes 64 ... 160

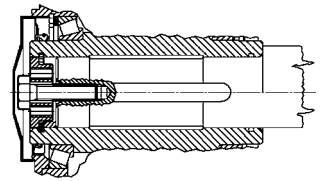
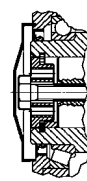
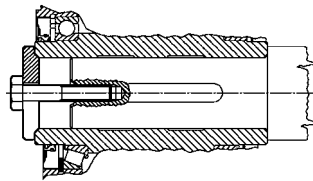
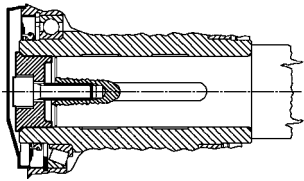
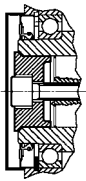

Helical and bevel helical
size 63

Helical and bevel helical
size MR 3l 63

Worm sizes 200, 250

Helical and bevel helical
sizes 180 ... 360

fig. 4c)

Axial fastening

fig. 4d)

Worm sizes 32 ... 50

Helical and bevel helical
size 50

Worm sizes 63 ... 161

Helical and bevel helical
sizes 64 ... 160

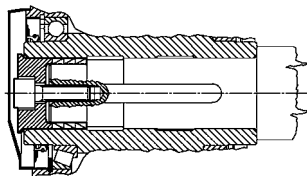
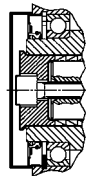

Fitting with key
and locking rings
fig. 4e), with key
and locking bush
fig. 4f)

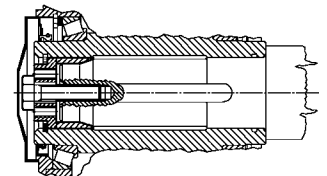
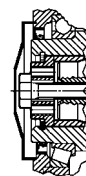

Helical and bevel helical
size 63

Worm sizes 200, 250

Helical and bevel helical
sizes 180 ... 360

fig. 4e)

fig. 4f)

Helical and bevel helical
sizes 50 ... 125

Helical and bevel helical
sizes 140 ... 6301

Helical and bevel helical
sizes 400 ... 6301

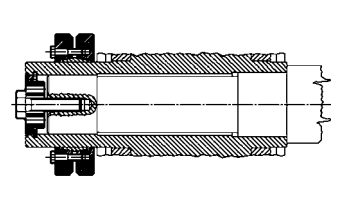
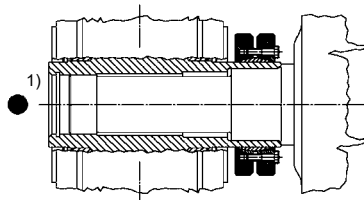
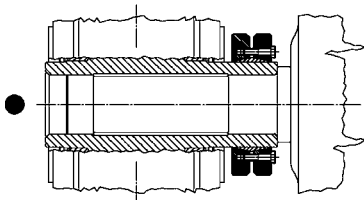

fig. 4g)

Fitting with shrink disk fig. 4g)



Rossi
Habasit Group

Solutions for
an evolving
industry

Rossi S.p.A.
Via Emilia Ovest 915/A
41123 Modena - Italy

Phone +39 059 33 02 88

info@rossi.com
www.rossi.com

UTD.045.09-2021.00_EN

© Rossi S.p.A. Rossi reserves the right to make any modification whenever to this publication contents. The information given in this document only contains general descriptions and/or performance features which may not always specifically reflect those described.

The Customer is responsible for the correct selection and application of product in view of its industrial and/or commercial needs, unless the use has been recommended by technical qualified personnel of Rossi, who were duly informed about Customer's application purposes. In this case all the necessary data required for the selection shall be communicated exactly and in writing by the Customer, stated in the order and confirmed by Rossi. The Customer is always responsible for the safety of product applications. Every care has been taken in the drawing up of the catalog to ensure the accuracy of the information contained in this publication, however Rossi can accept no responsibility for any errors, omissions or outdated data. Due to the constant evolution of the state of the art, Rossi reserves the right to make any modification whenever to this publication contents. The responsibility for the product selection is of the Customer, excluding different agreements duly legalized in writing and undersigned by the Parties.